

ASUS

**PA24A Series
LCD Monitor**

User Guide

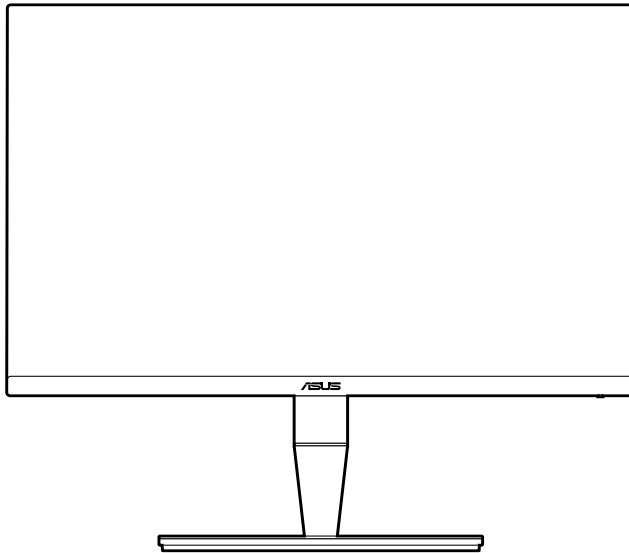

HDMI™
HIGH DEFINITION MULTIMEDIA INTERFACE

First Edition

July 2018

Copyright © 2018 ASUSTeK COMPUTER INC. All Rights Reserved.

No part of this manual, including the products and software described in it, may be reproduced, transmitted, transcribed, stored in a retrieval system, or translated into any language in any form or by any means, except documentation kept by the purchaser for backup purposes, without the express written permission of ASUSTeK COMPUTER INC. ("ASUS").

Product warranty or service will not be extended if: (1) the product is repaired, modified or altered, unless such repair, modification or alteration is authorized in writing by ASUS; or (2) the serial number of the product is defaced or missing.

ASUS PROVIDES THIS MANUAL "AS IS" WITHOUT WARRANTY OF ANY KIND, EITHER EXPRESS OR IMPLIED, INCLUDING BUT NOT LIMITED TO THE IMPLIED WARRANTIES OR CONDITIONS OF MERCHANTABILITY OR FITNESS FOR A PARTICULAR PURPOSE. IN NO EVENT SHALL ASUS, ITS DIRECTORS, OFFICERS, EMPLOYEES OR AGENTS BE LIABLE FOR ANY INDIRECT, SPECIAL, INCIDENTAL, OR CONSEQUENTIAL DAMAGES (INCLUDING DAMAGES FOR LOSS OF PROFITS, LOSS OF BUSINESS, LOSS OF USE OR DATA, INTERRUPTION OF BUSINESS AND THE LIKE), EVEN IF ASUS HAS BEEN ADVISED OF THE POSSIBILITY OF SUCH DAMAGES ARISING FROM ANY DEFECT OR ERROR IN THIS MANUAL OR PRODUCT.

SPECIFICATIONS AND INFORMATION CONTAINED IN THIS MANUAL ARE FURNISHED FOR INFORMATIONAL USE ONLY, AND ARE SUBJECT TO CHANGE AT ANY TIME WITHOUT NOTICE, AND SHOULD NOT BE CONSTRUED AS A COMMITMENT BY ASUS. ASUS ASSUMES NO RESPONSIBILITY OR LIABILITY FOR ANY ERRORS OR INACCURACIES THAT MAY APPEAR IN THIS MANUAL, INCLUDING THE PRODUCTS AND SOFTWARE DESCRIBED IN IT.

Products and corporate names appearing in this manual may or may not be registered trademarks or copyrights of their respective companies, and are used only for identification or explanation and to the owners' benefit, without intent to infringe.

Contents

Contents	iii
Notices	iv
Safety information	v
Care & Cleaning	vi
Takeback Services	vii
Chapter 1: Product introduction	
1.1 Welcome!	1-1
1.2 Package contents	1-1
1.3 Monitor introduction	1-2
1.3.1 Front view	1-2
1.3.2 Back view	1-3
1.3.3 Other Function(s)	1-4
Chapter 2: Setup	
2.1 Attaching the arm/base	2-1
2.2 Detaching the arm/base (for VESA wall mount)	2-1
2.3 Adjusting the monitor	2-2
2.4 Connecting the cables	2-4
2.5 Turning on the monitor	2-5
Chapter 3: General instructions	
3.1 OSD (On-Screen Display) menu	3-1
3.1.1 How to reconfigure	3-1
3.1.2 OSD function introduction	3-2
3.2 Specifications summary	3-12
3.3 Outline Dimensions	3-14
3.4 Troubleshooting (FAQ)	3-15
3.5 Supported operating modes	3-16

Notices

Federal Communications Commission Statement

This device complies with Part 15 of the FCC Rules. Operation is subject to the following two conditions:

- This device may not cause harmful interference, and
- This device must accept any interference received including interference that may cause undesired operation.

This equipment has been tested and found to comply with the limits for a Class B digital device, pursuant to Part 15 of the FCC Rules. These limits are designed to provide reasonable protection against harmful interference in a residential installation. This equipment generates, uses and can radiate radio frequency energy and, if not installed and used in accordance with the instructions, may cause harmful interference to radio communications. However, there is no guarantee that interference will not occur in a particular installation. If this equipment does cause harmful interference to radio or television reception, which can be determined by turning the equipment off and on, the user is encouraged to try to correct the interference by one or more of the following measures:

- Reorient or relocate the receiving antenna.
- Increase the separation between the equipment and receiver.
- Connect the equipment into an outlet on a circuit different from that to which the receiver is connected.
- Consult the dealer or an experienced radio/TV technician for help.



The use of shielded cables for connection of the monitor to the graphics card is required to assure compliance with FCC regulations. Changes or modifications to this unit not expressly approved by the party responsible for compliance could void the user's authority to operate this equipment.



As an Energy Star® Partner, our company has determined that this product meets the Energy Star® guidelines for energy efficiency.

Canadian Department of Communications Statement

This digital apparatus does not exceed the Class B limits for radio noise emissions from digital apparatus set out in the Radio Interference Regulations of the Canadian Department of Communications.

This class B digital apparatus complies with Canadian ICES-003.

This Class B digital apparatus meets all requirements of the Canadian Interference - Causing Equipment Regulations.

Cet appareil numérique de la classe B respecte toutes les exigences du Règlement sur le matériel brouiller du Canada.



Safety information

- Before setting up the monitor, carefully read all the documentation that came with the package.
- To prevent fire or shock hazard, never expose the monitor to rain or moisture.
- Never try to open the monitor cabinet. The dangerous high voltages inside the monitor may result in serious physical injury.
- If the power supply is broken, do not try to fix it by yourself. Contact a qualified service technician or your retailer.
- Before using the product, make sure all cables are correctly connected and the power cables are not damaged. If you detect any damage, contact your dealer immediately.
- Slots and openings on the back or top of the cabinet are provided for ventilation. Do not block these slots. Never place this product near or over a radiator or heat source unless proper ventilation is provided.
- The monitor should be operated only from the type of power source indicated on the label. If you are not sure of the type of power supply to your home, consult your dealer or local power company.
- Use the appropriate power plug which complies with your local power standard.
- Do not overload power strips and extension cords. Overloading can result in fire or electric shock.
- Avoid dust, humidity, and temperature extremes. Do not place the monitor in any area where it may become wet. Place the monitor on a stable surface.
- Unplug the unit during a lightning storm or if it will not be used for a long period of time. This will protect the monitor from damage due to power surges.
- Never push objects or spill liquid of any kind into the slots on the monitor cabinet.
- To ensure satisfactory operation, use the monitor only with UL listed computers which have appropriate configured receptacles marked between 100-240V AC.
- If you encounter technical problems with the monitor, contact a qualified service technician or your retailer.
- Adjustment of the volume control as well as the equalizer to other settings than the center position may increase the ear-/headphones output voltage and therefore the sound pressure level.



This symbol of the crossed out wheeled bin indicates that the product (electrical, electronic equipment, and mercury-containing button cell battery) should not be placed in municipal waste. Please check local regulations for disposal of electronic products.

AEEE yönetmeliğine uygundur

Care & Cleaning

- Before you lift or reposition your monitor, it is better to disconnect the cables and power cord. Follow the correct lifting techniques when positioning the monitor. When lifting or carrying the monitor, grasp the edges of the monitor. Do not lift the display by the stand or the cord.
- Cleaning. Turn your monitor off and unplug the power cord. Clean the monitor surface with a lint-free, non-abrasive cloth. Stubborn stains may be removed with a cloth dampened with mild cleaner.
- Avoid using a cleaner containing alcohol or acetone. Use a cleaner intended for use with the monitor. Never spray cleaner directly on the screen, as it may drip inside the monitor and cause an electric shock.

The following symptoms are normal with the monitor:

- You may find slightly uneven brightness on the screen depending on the desktop pattern you use.
- When the same image is displayed for hours, an afterimage of the previous screen may remain after switching the image. The screen will recover slowly or you can turn off the Power Switch for hours.
- When the screen becomes black or flashes, or cannot work anymore, contact your dealer or service center to fix it. Do not repair the screen by yourself!

Conventions used in this guide



WARNING: Information to prevent injury to yourself when trying to complete a task.



CAUTION: Information to prevent damage to the components when trying to complete a task.



IMPORTANT: Information that you **MUST** follow to complete a task.



NOTE: Tips and additional information to aid in completing a task.

Where to find more information

Refer to the following sources for additional information and for product and software updates.

1. **ASUS websites**

The ASUS websites worldwide provide updated information on ASUS hardware and software products. Refer to <http://www.asus.com>

2. **Optional documentation**

Your product package may include optional documentation that may have been added by your dealer. These documents are not part of the standard package.

Takeback Services

ASUS recycling and takeback programs come from our commitment to the highest standards for protecting our environment. We believe in providing solutions for our customers to be able to responsibly recycle our products, batteries and other components as well as the packaging materials.

Please go to <http://csr.asus.com/english/Takeback.htm> for detail recycling information in different region.

Congratulations!

This product is TCO Certified – for Sustainable IT



TCO Certified is an international third party sustainability certification for IT products. TCO Certified ensures that the manufacture, use and recycling of IT products reflect environmental, social and economic responsibility. Every TCO Certified product model is verified by an accredited independent test laboratory.

This product has been verified to meet all the criteria in TCO Certified, including:

Corporate Social Responsibility

Socially responsible production - working conditions and labor law in manufacturing country

Energy Efficiency

Energy efficiency of product and power supply. Energy Star compliant, where applicable

Environmental Management System

Manufacturer must be certified according to either ISO 14001 or EMAS

Minimization of Hazardous Substances

Limits on cadmium, mercury, lead & hexavalent chromium including requirements for mercury-free products, halogenated substances and hazardous flame retardants

Design for Recycling

Coding of plastics for easy recycling. Limit on the number of different plastics used.

Product Lifetime, Product Take Back

Minimum one-year product warranty. Minimum three-year availability of spare parts. Product takeback

Packaging

Limits on hazardous substances in product packaging. Packaging prepared for recycling

Ergonomic, User-centered design

Visual ergonomics in products with a display. Adjustability for user comfort (displays, headsets)

Acoustic performance – protection against sound spikes (headsets) and fan noise (projectors, computers)

Ergonomically designed keyboard (notebooks)

Electrical Safety, minimal electro-magnetic Emissions

Third Party Testing

All certified product models have been tested in an independent, accredited laboratory.

A detailed criteria set is available for download at www.tcodevelopment.com, where you can also find a searchable database of all TCO Certified IT products.

TCO Development, the organization behind TCO Certified, has been an international driver in the field of Sustainable IT for 20 years. Criteria in TCO Certified are developed in collaboration with scientists, experts, users and manufacturers. Organizations around the world rely on TCO Certified as a tool to help them reach their sustainable IT goals. We are owned by TCO, a non-profit organization representing office workers. TCO Development is headquartered in Stockholm, Sweden, with regional presence in North America and Asia.

For more information, please visit
www.tcodevelopment.com

1.1 Welcome!

Thank you for purchasing the ASUS® LCD monitor!

The latest widescreen LCD monitor from ASUS provides a broader, brighter and crystal-clear display, plus a host of features that enhance your viewing experience.

With these features, you can enjoy the convenience and delightful visual experience that the monitor brings to you!

1.2 Package contents

Check your package for the following items:

- ✓ LCD monitor
- ✓ Monitor base
- ✓ Quick start guide
- ✓ Warranty card
- ✓ Power cord
- ✓ HDMI cable
- ✓ USB Type-C to Type-C cable
- ✓ USB Type-C to Type-A cable
- ✓ DisplayPort cable
- ✓ Cable clip
- ✓ Color Calibration Testing Report
- ✓ Input/Output port cover
- ✓ Color Calibrator (for PA24AC-K only)



If any of the above items is damaged or missing, contact your retailer immediately.

1.3 Monitor introduction

1.3.1 Front view

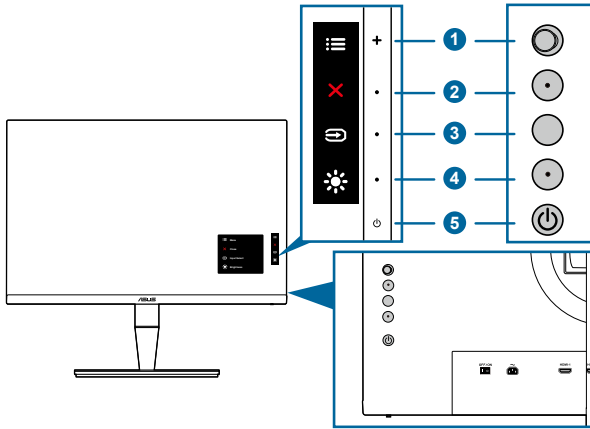

- ☰** Menu (5-way) button:
 - Press this button to enter the OSD menu.
 - Enacts the selected OSD menu items.
 - Increases/Decreases values or moves your selection up/down/left/right.
- ✕** Close button:
 - Exits the OSD menu.
 - Toggles the Key Lock function between on and off with a long press for 5 seconds.
- ↔** Input select button:
 - Selects an available input source.



Press **↔** button (Input Select button) to display HDMI-1, HDMI-2, DisplayPort or USB Type C signal after you connect HDMI/DisplayPort/USB cable with the monitor.

- ☀** Shortcut
 - Default: Brightness hotkey
 - To change the hotkey function, go to the Shortcut > Shortcut menu.
- ⏻** Power button/power indicator
 - Turns the monitor on/off.
 - The color definition of the power indicator is as the below table.

Status	Description
White	On
Amber	Standby mode
Off	Off

1.3.2 Back view

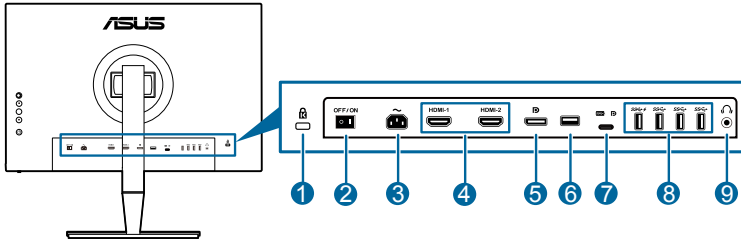

- 1. Kensington lock slot.**
- 2. Power switch.** Press the switch to turn on/off power.
- 3. AC-IN port.** This port connects the power cord.
- 4. HDMI ports.** These ports are for connection with an HDMI compatible device.
- 5. DisplayPort in.** This port is for connection with a DisplayPort compatible device.



The default setting of DisplayPort Stream in the OSD menu is DisplayPort 1.2. You can change it to DisplayPort 1.1 when your device output signal is DisplayPort 1.1.

- 6. USB 2.0 Type A.** This port is for service only.
- 7. USB 3.0 Type-C.** This port is for connection with a USB upstream cable. The connection supports USB power and data delivery.



This monitor is Super-Speed USB 3.0 compatible (5Gbps). The port offers Max. 60W power delivery with output voltage 5V, 9V, 12V, 15V and 20V. Connecting the USB Type-C cable can input the DisplayPort source, output power and enable the USB Type-A ports (downstream) on the monitor. Connecting the USB Type-C to Type-A cable only enables the USB Type-A ports (downstream) on the monitor.

- 8. USB 3.0 Type A.** These ports are for connection with USB devices, such as USB keyboard/mouse, USB flash drive, etc.



Port with  icon is BC1.2 DCP (Dedicated Charging Port) compliant with Max. 2A. When the USB upstream port is connected to a device, it will only charge 900mA.

- 9. Earphone jack.**

1.3.3 Other Function(s)

1. HDR

The monitor supports HDR format from input source HDMI-1, HDMI-2 or DisplayPort. When detecting HDR content, an "HDR ON" message will pop up and display in the Information page.



When displaying HDR content, the following function(s) are not available: Splendid menu, Blue Light Filter menu, Color menu, Trace Free, Uniformity Compensation, VividPixel, PIP/PBP Setting menu, QuickFit menu, Splendid Demo Mode and ECO Mode.

2.1 Attaching the arm/base

To assemble the monitor base:

1. Have the front of the monitor face down on a table.
2. Remove the input/output port cover (Figure 1).
3. Attach the base into the arm, making sure the tab on the arm fits into the groove on the base (Figure 2).

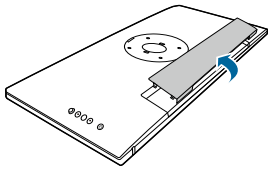

(Figure 1)

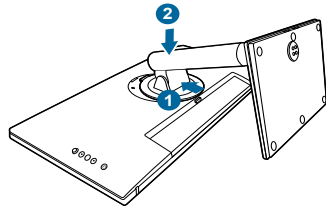

(Figure 2)



We recommend that you cover the table surface with soft cloth to prevent damage to the monitor.

2.2 Detaching the arm/base (for VESA wall mount)

The detachable arm/base of this monitor is specially designed for VESA wall mount.

To detach the arm/base:

1. Have the front of the monitor face down on a table.
2. Remove the input/output port cover (Figure 1).
3. Press the release button, and then detach the arm/base from the monitor (Figure 2).

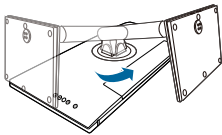

(Figure 1)

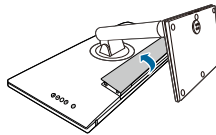

(Figure 2)



We recommend that you cover the table surface with soft cloth to prevent damage to the monitor.



- The VESA wall mount kit (100 x 100 mm) is purchased separately.
- Use only the UL Listed Wall Mount Bracket with minimum weight/load 22.7kg (Screw size: M4 x 10 mm).

2.3 Adjusting the monitor

- For optimal viewing, we recommend that you look at the full face of the monitor, then adjust the monitor to the angle that is most comfortable for you.
- Hold the stand to prevent the monitor from falling when you change its angle.
- You can adjust the monitor's angle from $+23^\circ$ to -5° , and it allows 45° swivel adjustment from either left or right. You can also adjust the monitor's height within ± 110 mm.

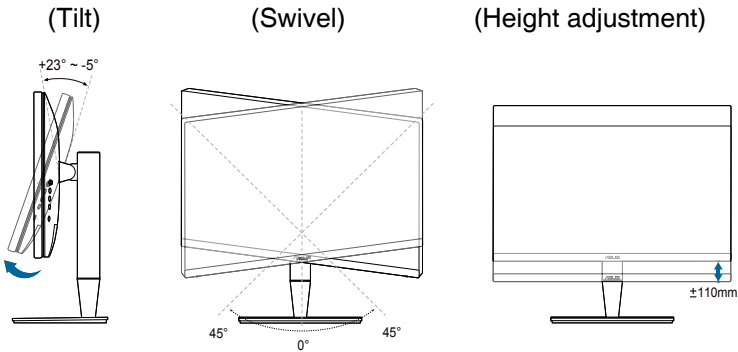

Pivoting the monitor

1. Lift the monitor to the highest position.
2. Tilt the monitor to its maximum angle.
3. Pivot the monitor to the angle you need.

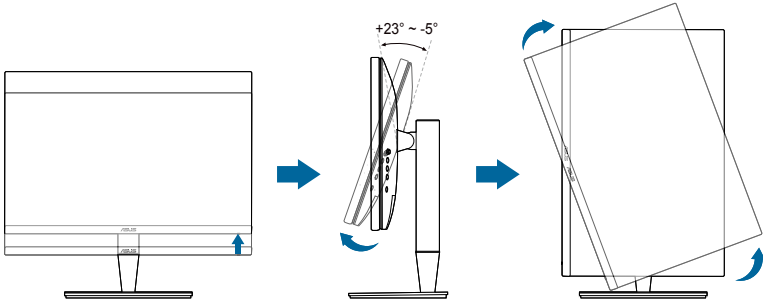

It is normal that the monitor slightly shakes while you adjust the viewing angle.

4. The OSD menu item will automatically rotate when the monitor rotates.

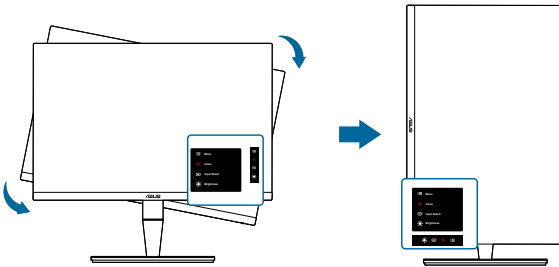

2.4 Connecting the cables

1. Connect the cables as the following instructions:

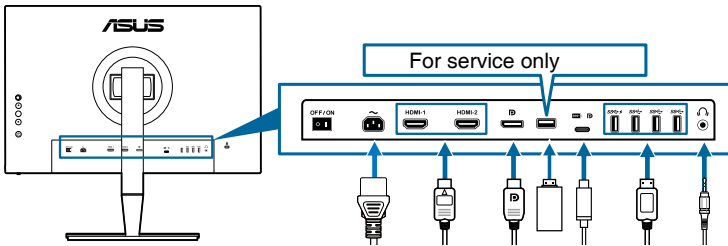

- **To connect the power cord:** Connect one end of the power cord securely to the monitor's AC input port, the other end to a power outlet.
- **To connect the HDMI/DisplayPort cable:**
 - a. Plug one end of the HDMI/DisplayPort cable to the monitor's HDMI/DisplayPort jack.
 - b. Connect the other end of the HDMI/DisplayPort cable to your device's HDMI/DisplayPort jack.
- **To use the earphone:** connect the end with plug type to the monitor's earphone jack when an HDMI/DisplayPort/USB Type-C (DisplayPort Alternate Mode) signal is fed.
- **To use the USB 3.0 ports:**
 - » Upstream: Use the supplied USB Type-C to Type-C or USB Type-C to Type-A cable. Make sure your computer is installed with the latest Windows 7/Windows 8.1/Windows 10 operating system. That will enable the USB ports on the monitor to work.
 - » Downstream: Plug the USB Type-A cable of your device to the monitor's USB Type-A jack.
 - » USB Type-A jack can be used for Color Calibrator.



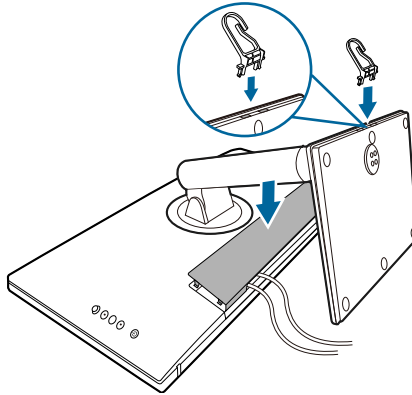

When these cables are connected, you can choose the desired signal from the Input Select item in the OSD menu.

2. Attach the input/output port cover and/or cable clip if needed.











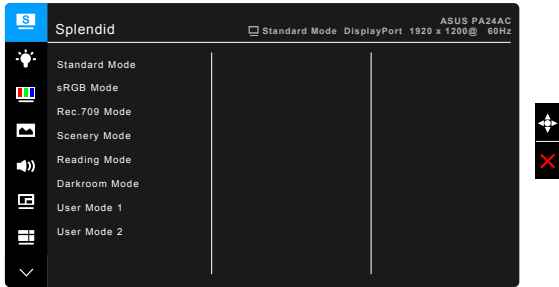

2.5 Turning on the monitor

Press the power button . See page 1-2 for the location of the power button. The power indicator  lights up in white to show that the monitor is ON.

3.1 OSD (On-Screen Display) menu

3.1.1 How to reconfigure



1. Press the  Menu (5-way) button to activate the OSD menu.
2. Move the  Menu (5-way) button up/down/left/right to navigate through the functions. Highlight the desired function and press the  Menu (5-way) button to activate it. If the function selected has a sub-menu, move the  Menu (5-way) button up/down to navigate through the sub-menu functions. Highlight the desired sub-menu function and press the  Menu (5-way) button or move the  Menu (5-way) button to activate it.
3. Move the  Menu (5-way) button up/down to change the settings of the selected function.
4. To exit and save the OSD menu, press the  button or move the  Menu (5-way) left repeatedly until the OSD menu disappears. To adjust other functions, repeat steps 1-3.

3.1.2 OSD function introduction

1. Splendid

This function contains 8 sub-functions you can select for your preference. Each mode has the Reset selection, allowing you to maintain your setting or return to the preset mode.



To activate this function, you need to do the following: disable HDR on your device.

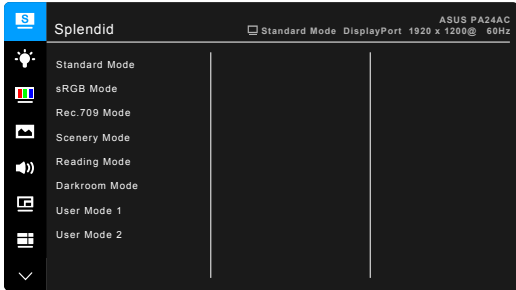

- **Standard Mode:** Best choice for document editing with SplendidPlus Video Enhancement.
- **sRGB Mode:** Compatible with sRGB color space, sRGB mode is the best choice for document editing.
- **Rec. 709 Mode:** Compatible with Rec.709 color space.
- **Scenery Mode:** Best choice for scenery photo display with SplendidPlus Video Enhancement.
- **Reading Mode:** This is the best choice for book reading.
- **Darkroom Mode:** This is the best choice for a weak ambient light environment.
- **User Mode 1/User Mode 2:** Allows you to make color adjustments in the Advanced Setting. You can also save one or two ProArt Calibration profiles as User Mode 1/User Mode 2 after executing ProArt Calibration and then have quick access here.



Please apply the following settings while performing ProArt color calibration via HDMI:

- Set output dynamic to full range.
- Set output color format to RGB.
- Set output color depth to 8 bit.

Function	Standard Mode	sRGB Mode	Scenery Mode	Reading Mode	Darkroom Mode	User Mode 1 / User Mode 2
Color Temp.	6500K	Fixed 6500K	6500K	Fixed	6500K	Fixed 6500K
Brightness	50	Fixed 50	100	9	0	50
Contrast	80	Fixed 80	80	Fixed 80	80	80
Saturation	Fixed 50	Fixed 50	Middle 50	Fixed 50	Middle 50	Middle 50
Hue	Fixed 50	Fixed 50	Middle 50	Fixed 50	Middle 50	Middle 50
Advanced Setting	Disable	Disable	Enable	Disable	Enable	Disable
Black Level	Enable	Disable	Enable	Enable	Enable	Enable
Gamma	2.2	Fixed 2.2	Fixed 2.2	2.2	2.2	Fixed 2.2
Uniformity Compensation	Off	Off	Fixed Off	Fixed Off	Fixed Off	Fixed Off

2. Blue Light Filter

In this function, you can adjust the blue light filter level.



To activate this function, you need to do the following: disable HDR on your device.

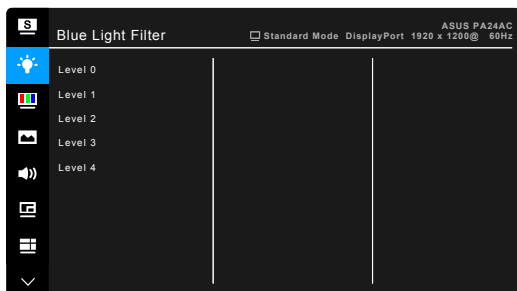

- **Level 0:** No change.
- **Level 1~4:** The higher the level, the less blue light is scattered. When Blue Light Filter is activated, the default settings of Standard Mode will be automatically imported. Between Level 1 to Level 3, the Brightness function is user-configurable. Level 4 is optimized setting. It is compliance with TUV Low Blue Light Certification. The Brightness function is not user-configurable.



When Level 1~4 is selected, Uniformity Compensation will be automatically set to OFF.



Please refer to the following to alleviate eye strains:

- Users should take some time away from the display if working for long hours. It is advised to take short breaks (at least 5 mins) after around 1 hour of continuous working at the computer. Taking short and frequent breaks is more effective than a single longer break.
 - To minimize eye strain and dryness in your eyes, users should rest the eye periodically by focusing on objects that are far away.
 - Eye exercises can help to reduce eye strain. Repeat these exercises often. If eye strain continues please consult a physician. Eye exercises: (1) Repeating look up and down (2) Slowly roll your eyes (3) Move your eyes diagonal.
 - High energy blue light may lead to eye strain and AMD (Age-Related Macular Degeneration). Blue light Filter to reduce 70% (max.) harmful blue light to avoid CVS (Computer Vision Syndrome).
-

3. Color

Set a desired color setting from this menu.



To activate this function, you need to do the following: disable HDR on your device.

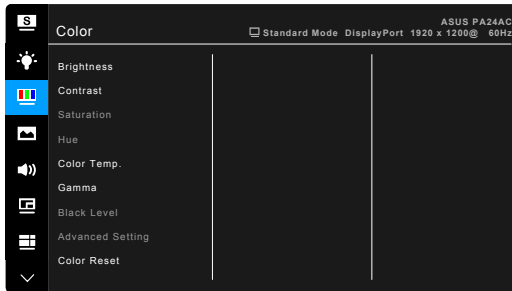

- **Brightness:** The adjusting range is from 0 to 100.



The function is not available when ECO Mode is ON.

- **Contrast:** The adjusting range is from 0 to 100.



The function is not available when ECO Mode is ON.

- **Saturation:** The adjusting range is from 0 to 100.
- **Hue:** Shifts the image color between green and purple.
- **Color Temp.:** Contains 4 modes including 9300K, 6500K, 5500K and 5000K.
- **Gamma:** Allows you to set the color mode to 2.6, 2.4, 2.2, 2.0 or 1.8.
- **Black Level:** To adjust the initialized 1st signal level of darkest gray level.
- **Advanced Setting:**
 - * Six-axis Hue adjustment.
 - * Six-axis Saturation adjustment.
 - * Adjusts the gain levels for R, G, B.
 - * Adjusts the black level offset values for R, G, B.
- **Color Reset:**
 - * **Current Splendid color mode reset:**
Resets the color settings of current color mode to the factory default value.
 - * **All Splendid color mode reset:**
Resets the color settings of all color modes to the factory default value.

4. Image

Set the image related setting from this menu.

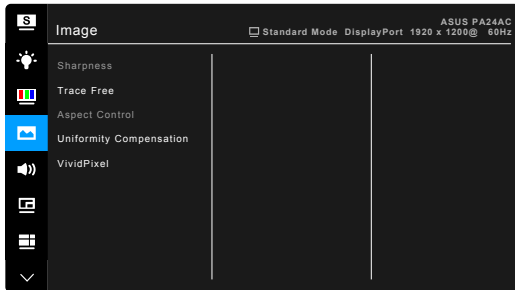

- **Sharpness:** The adjusting range is from 0 to 100.



The function is not available when HDR is enabled on your device.

- **Trace Free:** Adjusts the response time of the monitor.



The function is not available when HDR is enabled on your device.

- **Aspect Control:** Adjusts the aspect ratio to Full, 4:3, 1:1, Zoom or OverScan.



4:3 is only available when input source is in 4:3 format. OverScan is only available for the HDMI input source.

- **Uniformity Compensation:** Adjusts different areas of the screen to reduce any screen uniformity errors, providing consistent brightness and color across the entire screen.



To activate this function, you need to do the following: turn off Dynamic Dimming. When this function is activated, Blue Light Filter will be automatically set to OFF.

- **VividPixel:** Enhances the outline of the displayed picture and generates high-quality images on screen.

5. Sound

You can adjust Volume, Mute and Source from this menu.

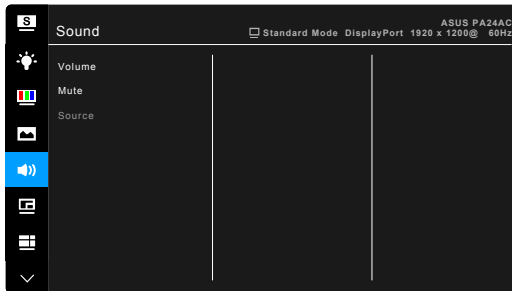

- **Volume:** the adjusting range is from 0 to 100.
- **Mute:** toggles the monitor sound between on and off.
- **Source:** decides the monitor sound comes from which source.

6. PIP/PBP Setting

The PIP/PBP Setting allows you to open up another sub-window connected from another video source besides the main-window from your original video source. By activating this function, the monitor displays up to 2 pictures from different video sources.



To activate this function, you need to do the following: disable HDR on your device, turn off Adaptive-Sync and Dynamic Dimming.

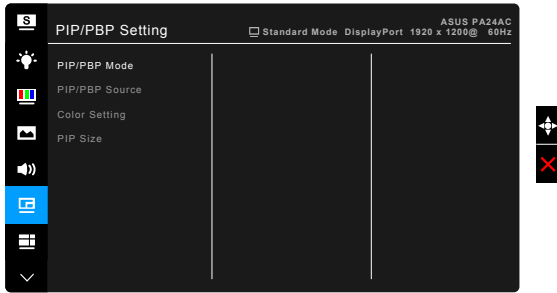

- **PIP/PBP Mode:** Selects PIP, PBP function, or turn it off.
- **PIP/PBP Source:** Selects the video input source from among HDMI-1, HDMI-2, DisplayPort, and USB Type-C. The table below shows the input source combinations.



		Main-window			
		HDMI-1	HDMI-2	DisplayPort	USB Type-C
Sub-window (does not support HDR/ Adaptive-Sync)	HDMI-1	Yes	Yes	Yes	Yes
	HDMI-2	Yes	Yes	Yes	Yes
	DisplayPort	Yes	Yes	Yes	Yes
	USB Type C	Yes	Yes	Yes	Yes

- **Color Setting:** Selects an individual Splendid Mode for the selected PIP/ PBP source.
- **PIP Size:** Adjusts the PIP size to Small, Middle, or Large. (Only available for the PIP mode).

7. QuickFit

You can have a preview of the document or photo layout directly on screen without printing test copies.



- **Customization:** You can decide the frame size by moving the  Menu (5-way) button up/down/left/right. You can press the  Menu (5-way) button for longer than 3 seconds to switch the measurements between millimeter and inch.

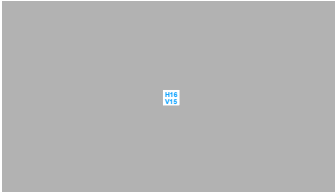

- **Ruler:** This pattern presents physical ruler on top and left side. You can press the  Menu (5-way) button for longer than 3 seconds to switch the measurements between metric and imperial.

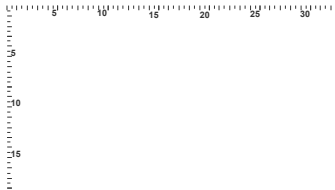

- **Alignment:** This facilitates designers and users to organize content and layout on one page and achieve a consistent look and feel.



- **A4:** You can view the documents in real size on the screen.

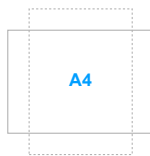

- **B5:** You can view the documents in real size on the screen.



8. Input Select

In this function, you can select your desired input source.

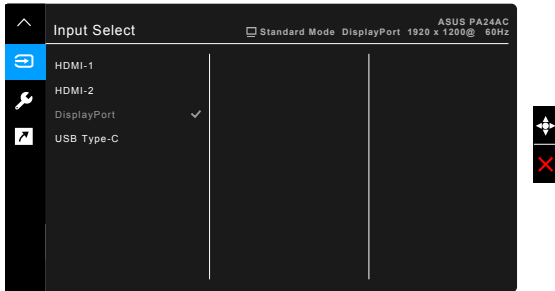

9. System Setup

Allows you to adjust the system.

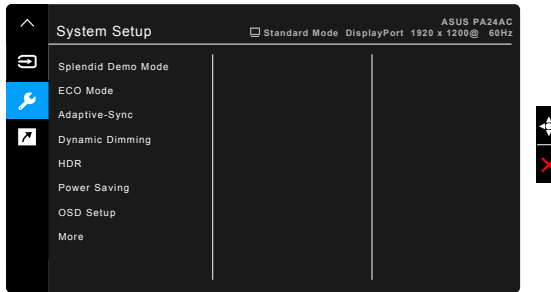

- **Splendid Demo Mode:** Splits the screen into two for Splendid modes comparison. (Scenery mode only)
- **ECO Mode:** Reduces power consumption.



The function is not available when Dynamic Dimming is ON.

- **Adaptive-Sync** (Available when HDMI or DisplayPort source is selected): Allows an Adaptive-Sync supported* graphics source to dynamically adjust display refresh rate based on typical content frame rates for power efficient, virtually stutter free and low-latency display update.



* Adaptive-Sync can only be activated within 48Hz ~ 70Hz.

* For supported GPUs, minimum PC system and driver requirements, please contact the GPU manufactures.

* To activate this function, you need to do the following: turn off PIP/PBP mode and set DisplayPort Stream to DisplayPort 1.2.

- **Dynamic Dimming:** Synchronizes with contents while contrast changing to execute backlight dynamic dimming.



To activate this function, you need to do the following: turn off ECO Mode. When this function is activated, the following function(s) will not be available: Uniformity Compensation and PIP/PBP.

- **HDR:**
 - * “HDR ASUS” .
 - * “HDR_Display HDR” complies with VESA Display HDR.
- **Power Saving:**
 - * “1st Level” allows the USB Type-C and USB Type-A ports to charge external devices when the monitor enters power saving mode and USB upstream cable is connected. USB Type-C signal can also be automatically detected if available.
 - * “Deep Level” does not allow all ports to charge external devices and keeps signals from being automatically detected when the monitor enters power saving mode to achieve the maximum benefit of saving power.



When setting is at 1st Level, only downstream port with BC1.2 function can charge the device with the upstream cable unplugged.

- **OSD Setup:**
 - * Adjusts the OSD timeout from 10 to 120 seconds.
 - * Enables or disables the DDC/CI function.
 - * Adjusts the OSD background from opaque to transparent.
 - * Adjusts the OSD rotation.
- **Language:** There are 21 languages for your selection, including English, French, German, Italian, Spanish, Dutch, Portuguese, Russian, Czech, Croatian, Polish, Romanian, Hungarian, Turkish, Simplified Chinese, Traditional Chinese, Japanese, Korean, Thai, Indonesia, Persian.
- **DisplayPort Stream:** Compatibility with graphic card. Select DisplayPort 1.1 or DisplayPort 1.2 by graphic card DP version.



DisplayPort 1.1 is only available when Adaptive-Sync is OFF.

- **Keylock:** To disable all function keys. Press the second button from the top over five seconds to cancel the key lock function.
- **Power Indicator:** Turns the power LED indicator on/off.

- **Information:** Shows the monitor information.
- **All Reset:** “Yes” allows you to restore the default settings.

10. Shortcut

Defines the functions for Shortcut button.

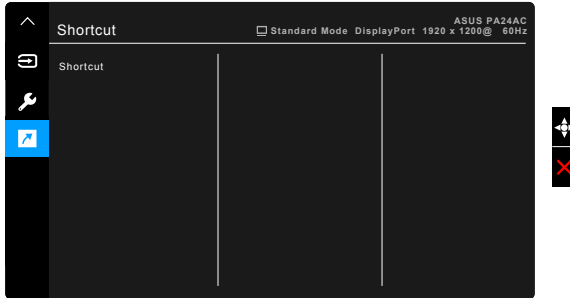

- **Shortcut:** selects a function for Shortcut button.



When a certain function is selected or activated, your shortcut key may not support. Available function choices for shortcut: Blue Light Filter, Brightness, Contrast, PIP/PBP Setting, Color Temp., QuickFit, User Mode 1, User Mode 2

3.2 Specifications summary

Panel Type	TFT LCD
Panel size	24.0" (16:10, 61.13 cm) wide screen
Max. Resolution	1920 x 1200
Pixel pitch	0.270 mm
Brightness (Typ.)	350 nits; Peak 400 cd/m ²
Contrast Ratio (Typ.)	1000:1
Contrast Ratio (Max.)	100,000,000:1 (with Dynamic Dimming on)
Viewing angle (H/V) CR>10	178°/178°
Display colors	16.7 million (8 bits)
Color gamut (Typ.)	sRGB 100%
Response time	5 ms (Gray to gray)
SplendidPlus Video Enhancement	Yes
SplendidPlus selection	8 video preset modes
Color temperature selection	4 color temperatures
Digital input	HDMI v2.0a, DisplayPort v1.2, USB Type-C
Earphone jack	Yes
Audio input	No
Speaker (Built-in)	2W x 2 stereo, RMS
USB 3.0 port	Upstream x 1, Downstream x 4
Colors	Gray & Black
Power LED	White (On)/Amber (Standby)
Tilt	+23° ~ -5°
Swivel	+45° ~ -45°
Pivot	+90°; -90°
Height Adjustment	110 mm
Kensington lock	Yes
AC input voltage	AC: 100~240V
Power consumption	Power On: < 21 W** (Typ.), Standby: < 0.5 W (Typ.), Power Off: 0 W (Switch off)
Temperature (Operating)	0°C~40°C
Temperature (Non-operating)	-20°C~+60°C
Dimension (W x H x D)	532 mm x 488 mm x 202 mm (with stand, highest) 532 mm x 488 mm x 92 mm (with stand, lowest) 532 mm x 349 mm x 55 mm (without stand) 650 mm x 260 mm x 430 mm (package)
Weight (Esti.)	6.5 kg (Net); 4.28 kg (without stand); 9.0 kg (Gross)
Multi-languages	21 languages (English, French, German, Italian, Spanish, Dutch, Portuguese, Russian, Czech, Croatian, Polish, Romanian, Hungarian, Turkish, Simplified Chinese, Traditional Chinese, Japanese, Korean, Thai, Indonesian, Persian)

Accessories	Quick start guide, Warranty card, Power cord, HDMI cable, USB Type-C to Type-C cable, USB Type-C to Type-A cable, DisplayPort cable, Cable clip, Color Calibration Testing Report, Input/Output port cover, Color Calibrator (for PA24AC-K only)
Compliance and Standards	Energy Star**, UL/cUL, CB, CE, EuP, FCC, CCC, BSMI, CU, VCCI, TCO 7.0, J-MOSS, RoHS, WEEE, PSE, KCC, ICES-3, ErP, CEL, ISO 9241-307, UkrSEPRO, RCM, MEPS, PC Recycle, KC, e-Standby, TUV Flicker Free, TUV Low Blue Light, Windows 7, 8.1 and 10 WHQL, Mac Compliance***

*Specifications are subject to change without notice.

**measuring a screen brightness of 200 nits without audio/USB/Card reader connection.

***Requires Mac OS 10.10.x, 10.11.x, 10.12.x.

3.3 Outline Dimensions

ASUS PA24A Outline Dimension
 *Unit: mm(Inch)

Pivot: ± 30 Degree

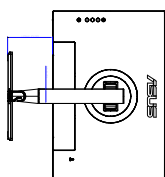
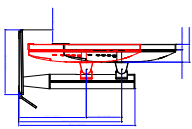
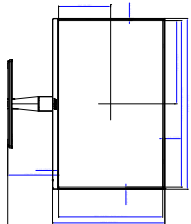
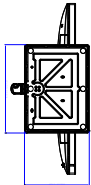
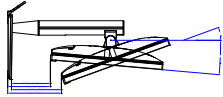
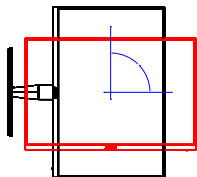
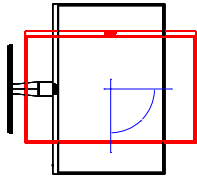

Swivel: ± 45 Degree

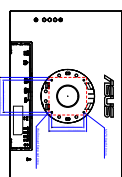
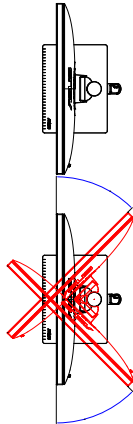

3.4 Troubleshooting (FAQ)

Problem	Possible Solution
Power LED is not ON	<ul style="list-style-type: none"> • Press the  button to check if the monitor is in the ON mode. • Check if the power cord is properly connected to the monitor and the power outlet. • Check if the power switch is ON.
The power LED lights amber and there is no screen image	<ul style="list-style-type: none"> • Check if the monitor and the computer are in the ON mode. • Make sure the signal cable is properly connected the monitor and the computer. • Inspect the signal cable and make sure none of the pins are bent. • Connect the computer with another available monitor to check if the computer is properly working.
Screen image is too light or dark	<ul style="list-style-type: none"> • Adjust the Contrast and Brightness settings via OSD.
Screen image bounces or a wave pattern is present in the image	<ul style="list-style-type: none"> • Make sure the signal cable is properly connected to the monitor and the computer. • Move electrical devices that may cause electrical interference.
Screen image has color defects (white does not look white)	<ul style="list-style-type: none"> • Inspect the signal cable and make sure that none of the pins are bent. • Perform All Reset via OSD. • Adjust the R/G/B color settings or select the Color Temperature via OSD.
No sound or sound is low	<ul style="list-style-type: none"> • Ensure that the HDMI/DisplayPort cable is properly connected to the monitor and the computer. • Adjust the volume settings of both your monitor and HDMI/DisplayPort device. • Ensure that the computer sound card driver is properly installed and activated.
Black screen shows up or abnormal image displays when the input source is DisplayPort	<ul style="list-style-type: none"> • Set DisplayPort Stream from DisplayPort 1.2 (default) to DisplayPort 1.1 via OSD.

3.5 Supported operating modes

Resolution Frequency	Horizontal Frequency (KHz)	Vertical Frequency (Hz)	Pixel (MHz)
640x480	31.47(N)	59.94(N)	25.18
640x480	35.00(N)	66.66(N)	30.24
640x480	37.87(N)	72.82(N)	31.5
640x480	37.5(N)	75.00(N)	31.5
720x400	31.47(N)	70.08(P)	28.32
800x600	35.16(P)	56.25(P)	36.00
800x600	37.88(P)	60.32(P)	40.00
800x600	48.08(P)	72.12(P)	50.00
800x600	46.86(P)	75.00(P)	49.50
832X624	49.72(P/N)	74.55(P/N)	57.28
1024x768	48.36(N)	60.00(N)	65.00
1024x768	56.476(N)	70.069(N)	75.00
1024x768	60.02(N)	75.00(N)	78.75
1152x864	67.5(P/N)	75.00(P/N)	108.00
1280x960	60.00(P)	60.00(N)	108.00
1280x1024	63.98(P)	60.02(P)	108.00
1280x1024	79.98(P)	75.02(P)	135.00
1366x768	47.712(P)	59.79(P)	85.50
1440x900	55.94(N)	59.89(P)	106.50
1600x1200	75.00(P)	60.00(P)	162.00
1680x1050	65.29(N)	60.00(P)	146.25
1920x1080	67.5(P)	60.00(P)	148.5
1920x1200 (Reduced Blanking)	74.038(P)	59.95(N)	154

Timing Name	Pixel Format	Horizontal Frequency (kHz)	Vertical Frequency (Hz)	Pixel Rate (MHz)
480p	720 x 480	31.469	60	27
720p60	1280 x 720	45	60	74.25
576p	720 x 576	31.25	50	27
720p50	1280 x 720	37.5	50	74.25
1080p60	1920 x 1080	67.5	60	148.5
1080p50	1920 x 1080	56.25	50	148.5